



Votre distributeur
et réparateur
T. 01 76 21 07 46
www.tlm77.com

HADEF®





20/94 AFR

Einschienen- Rollfahrwerk/ Monorail- Push Travel Trolley / Chariot à pousser manuelle

ISO 9001
certified company

PREMIUM LINE

- 

Integrierte Absturz- und Auflaufsicherung
Integrated derailment and bumping protection
Avec anti- chute et anti- basculement
- 

Laufrollenprofil passend für alle Normträger
Adjustable to all standard beam sizes
Adaptable sur tous profils de roulement standard
- 

Kugelgelagerte Laufrollen
Trolley wheels with ball bearing
Galets avec roulement à billes
- 

Verzinkte Lastbolzen, Einstellscheiben und Befestigungsmuttern
Zinc plated load bars, washers and locking nuts
Traverses, entretoises et bagues zinguées
- 

Deutsche Herstellung
Manufactured in Germany
Fabrication Européenne



Auch als Haspel-, Elektro- oder Druckluftfahrwerk lieferbar
Also available as hand geared, electric- or pneumatic trolley
Aussi disponible comme chariot à avance par chaîne, chariot électrique ou pneumatique

Tragfähigkeit Capacity Capacité	Flanschbreite von - bis bei Lastbolzengröße Flange width from - to for load bar size Largeur de fer de - à pour traverse		Kurvenradius min. min. curve radius Radius de courbe min.		Gewicht Weight Poids	
	1N mm	2N mm	Standard Fahrwerk	modifiziertes Fahrwerk	1N ca. kg approx. kg env. kg	2N ca. kg approx. kg env. kg
			standard trolley	modified trolley		
kg			m	m ^{(1) (2)}		
500	50 - 146	147 - 302	-	-	7,9	9,7
1000	50 - 179	180 - 310	3,0	1,0	13,3	14,3
2000	66 - 185	186 - 310	3,5	1,5	29,1	31,7
3200	74 - 196	197 - 310	6,5	1,8	58,3	62,5
4000	74 - 196	197 - 310	6,5	1,8	58,3	62,5
5000	74 - 192	193 - 310	7,0	2,0	74,7	78,6
6300	119 - 215	216 - 312	8,0	2,2	159,4	164,2
7500	119 - 215	216 - 312	8,0	2,2	159,4	164,2
10000	119 - 215	216 - 312	8,0	2,2	159,4	164,2
12000	119 - 215	216 - 312	8,0	2,2	159,4	164,2
15000	160 - 310	-	-	4,5	521,5	-
20000	160 - 310	-	-	4,5	521,5	-
25000	160 - 310	-	-	4,5	745,2	-

(1) Optional gegen Mehrpreis./ As option for add. price./ Option pour prix additionnel.

(2) noch kleinere Kurvenradien auf Anfrage./ Smaller curve radius on request./ Radius de courbe plus petit sur demande.



20/94 AFR

HADEF®



Einschienen- Rollfahrwerk/ Monorail- Push Travel Trolley/
Chariot à pousser manuelle

ISO 9001
certified company

PREMIUM LINE

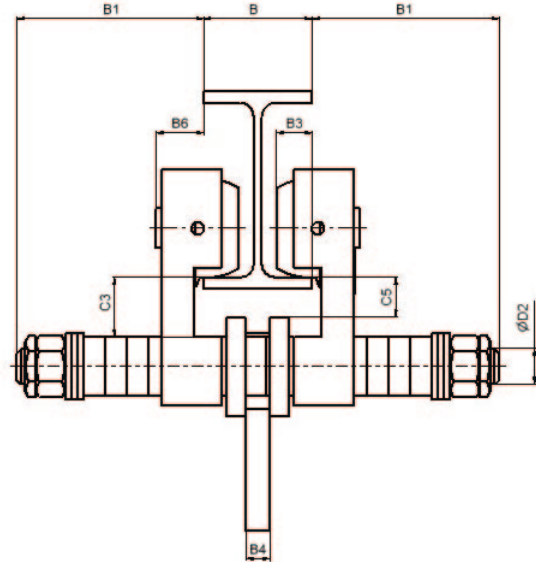
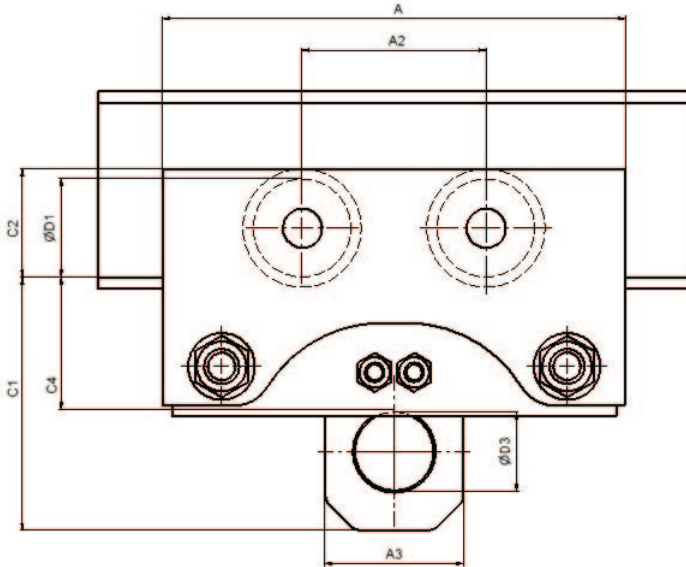

Tragfähigkeit Capacity Capacité	Hauptabmessungen in mm Main dimensions in mm Dimensions principales en mm																	
	B Flanschbreite von - bis bei Lastbolzengröße Flange width from - to for load bar size Lageur de fer de - à pour traverse		A			B1 bei Lastbolzengröße at load bar size pour traverse		B3	B4	B6	C1	C2	C3	C4	C5	Ø D1	Ø D2	Ø D3
kg	1N	2N	A	A2	A3	1N	2N	B3	B4	B6	C1	C2	C3	C4	C5	Ø D1	Ø D2	Ø D3
500	50 - 146	147 - 302	234	93	70	97	126	18	12	24	128	55	30	108	20	50	18	40
1000	50 - 179	180 - 310	287	142	70	97	95	20	12	31	132	78	31	112	25	65	20	40
2000	66 - 185	186 - 310	350	172	95	133	135	23	15	40	199	99	35	166	31	85	30	55
3200	74 - 196	197 - 310	428	209	120	145	145	26	20	46	234	134	41	186	32	120	36	73
4000	74 - 196	197 - 310	428	209	120	145	145	26	20	46	234	134	41	186	32	120	36	73
5000	74 - 192	193 - 310	492	223	125	153	164	26	20	53	256	137	38	206	38	120	39	73
6300	119 - 215	216 - 312	650	253	170	183	183	37	35	62	277	168	45	234	41	150	48	80
7500	119 - 215	216 - 312	650	253	170	183	183	37	35	62	277	168	45	234	41	150	48	80
10000	119 - 215	216 - 312	650	253	170	183	183	37	35	62	277	168	45	234	41	150	48	80
12000	119 - 215	216 - 312	650	253	170	183	183	37	35	62	277	168	45	234	41	200	48	80
15000	160 - 310	-	975	380	650	206	-	46	50	103	402	269	36	348	46	250	75	100
20000	160 - 310	-	975	380	650	206	-	46	50	103	402	269	36	348	46	250	75	100
25000	160 - 310	-	1100	432	775	191	-	53	80	102	371	319	40	299	46	300	75	76



**+** Optionen/ Options / Options

Drehschemelfahrwerk für sehr
kleine Kurvenradien
Swivelling trolley for very small
curve radius
Boogie pour radius de courbe
plus petite



größere Flanschbreiten möglich
larger flange width available
largeur de fer plus grande possible



Feststellvorrichtung
Beam locking device
Dispositif de blocage sur fer

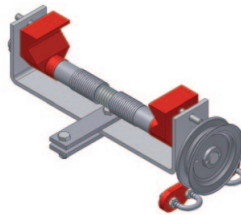

Gummipuffer
Rubber end stops
Butées caoutchouc

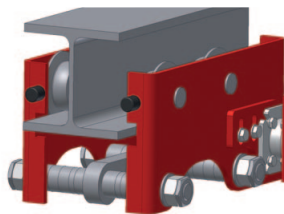

Zahnstangenantrieb
Rack and pinion drive
Entraînement sur crémaillère

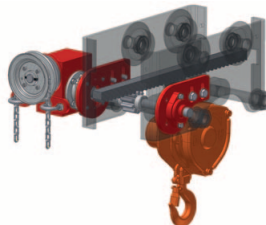

Komplett verzinkte Ausführung
Totally zinc plated trolley
Réalisation entièrement zinguée



Ausführung
version
ATEX
version

